

Canon

EOS

**REBEL** / **REBEL**  
**K2** **DATE** **K2**

**3000** **DATE** / **3000** **DATE**



English

**E**

INSTRUCTIONS

# Thank you for purchasing a Canon product.

The EOS REBEL K2 (DATE) / 3000V (DATE) is a very compact autofocus, single-lens reflex camera. It can be used for a wide variety of subjects and situations with fully automatic and user-controlled shooting modes.

Read this Instructions and familiarize yourself with your new camera before taking pictures.

Also read "Handling Cautions" on page 4 to prevent camera malfunction and damage.

**Keep this instruction booklet handy for easy reference.**

## Before Using Your Camera

- Before shooting an important event, be sure to take test shots to make sure the camera operates properly.
- EOS cameras have a lens mount for dedicated operation (autofocusing, exposure control, etc.) with Canon EF lenses. Using a non-Canon EF lens with an EOS camera may not result in proper camera or lens operation. Note that the warranty does not cover any camera malfunction or damage occurring with the use of non-Canon products.

## Conventions Used in this Instructions

- The  icon indicates the Main Dial.
- All operation procedures described in this booklet assume that the Mode Dial is set to a mode except <OFF>. Before proceeding with any operation, be sure that the Mode Dial is set to a shooting mode.
- Reference page numbers are indicated by (p.\*\*).
- The camera control icons and markings used in this booklet correspond to the actual icons and markings found on the camera.
- The (4) and (6) icons indicate that the respective function remains in effect for 4 and 6 sec. respectively after the button is released.

# Contents

Conventions Used in this Instructions .....	2
Handling Cautions .....	4
Nomenclature .....	6

## 1 Before You Start.....11

Installing the Batteries .....	11
Checking the Battery Level.....	12
Mounting and Detaching a Lens.....	13
How the Shutter Button Works .....	14
⊗ Loading and Unloading Film .....	15
⊗ Midroll Rewind .....	16

## 2 Fully Automatic Shooting.....17

Since everything is automatic, all you do is press the shutter button.

## 3 User-Controlled Shooting.....27

You can set the desired shutter speed or aperture value to obtain the exposure you want. You take control of the camera.

## Reference.....44

### Symbols



The Caution symbol alerts you to actions to prevent shooting problems.



The Note symbol gives supplemental information.

# Handling Cautions

## Camera Care and Storage

- The camera is a precision instrument. Do not drop it or subject it to physical shock.
- The camera is not waterproof and should not be used in wet conditions or underwater. If the camera gets wet, take it to your nearest Canon dealer as soon as possible. If small amounts of water splash onto the camera, wipe it with a clean dry cloth. If the camera is exposed to salty air, wipe it thoroughly with a slightly damp cloth.
- Do not leave the camera in places prone to excessive heat such as in a car on a sunny day. Excessive heat can cause the camera to malfunction.
- The camera contains precision electronic circuitry. Never attempt to disassemble the camera.
- Use only a blower brush to blow away any dust on the lens, eyepiece, mirror, focusing screen, film compartment, etc. Do not clean the camera body or lens with any cleaner containing an organic solvent. For stubborn dirt, consult your nearest Canon dealer.
- The shutter curtains are extremely thin. Use only a blower to clean them. Be careful not to blow air too forcefully on the shutter curtains. The shutter curtains can be easily deformed or damaged. Also, when loading and unloading film, be careful not to touch the shutter curtains.
- Do not touch the electrical contacts with your fingers. Otherwise corrosion may develop on the contacts, resulting in improper camera operation.
- If the camera is not to be used for an extended period, remove the battery. Store the camera in a well-ventilated, cool, dry place. During the storage period, press the shutter button to release the shutter a few times once in a while.
- Avoid storing the camera in a laboratory, cabinet, etc., where corrosive chemicals are present.

- If you have not used the camera for some time or are planning to take shots you will not want to lose (overseas vacation, etc.), have the camera checked by your Canon dealer beforehand, or check for yourself that the camera components are working properly.



## LCD Displays

By their nature, LCD displays react more slowly at low temperatures, and may appear dark at high temperatures. The display will return to normal at room temperature.

## Batteries

- Before installing the batteries, wipe the battery contacts to remove any fingerprints and smudges. This is to prevent faulty connections and corrosion.
- Never disassemble or recharge the batteries. Also, never store a battery in high-temperature places or short circuit the battery contacts or toss a battery into a fire.
- Although the batteries work well even at low temperatures, battery performance may decline slightly at freezing temperatures. In such a case, keep spare batteries warm in a pocket, etc., and use and warm the batteries alternately.

## How Low Battery Levels Affect Camera Operation

On the LCD panel, if the  icon blinks or it is not displayed, a proper exposure can still be obtained as long as the shutter releases. However, when the battery level is low, film advance and auto rewind might stop midway or not work at all and  icon may blink on the LCD panel. After the batteries are replaced with new ones, film advance will be possible and film rewind can resume by pressing the  button.

## Lens Electrical Contacts

After detaching the lens from the camera, put on the lens caps or put down the lens with the rear end up to avoid scratching the lens surface and electrical contacts.



# Nomenclature

- Reference page numbers are indicated by (p.\*\*).

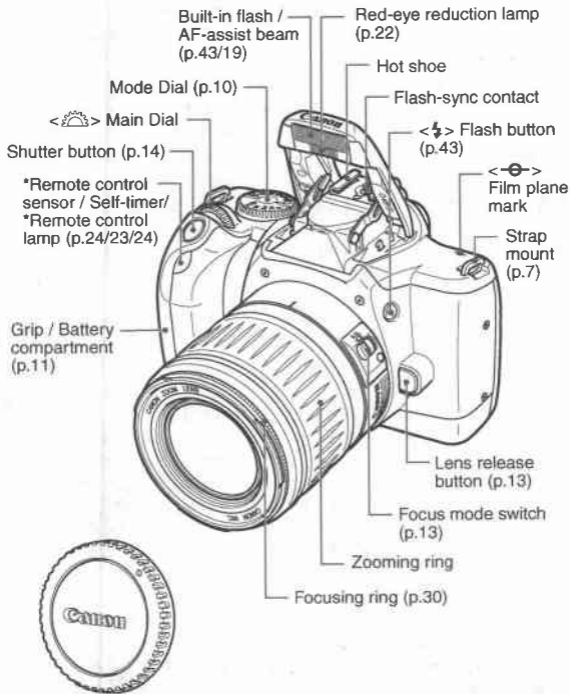

Body cap (p.13)

\* DATE Model only

\*\*With an EX-series Speedlite.

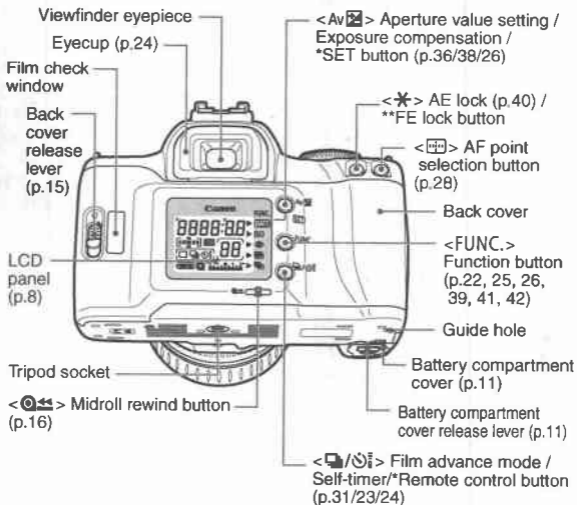

## Attaching the Strap

Pass the end of the strap through the camera's strap mount from the bottom. Then pass it through the strap's buckle as shown in the illustration. Pull the strap to make sure it does not slip out of the buckle.

- The eyepiece cover is also attached to the strap. (p.24)

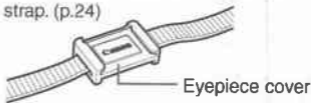
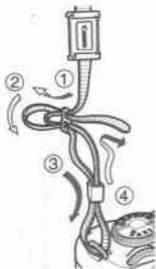

# Nomenclature

## LCD Panel

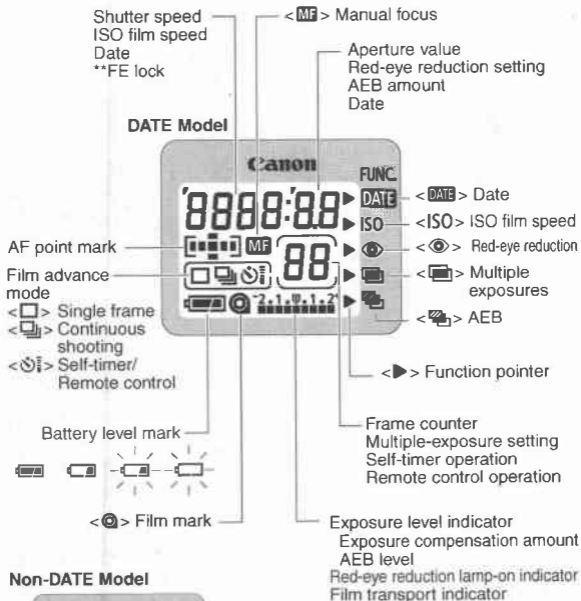

### Non-DATE Model



\*\* With an EX-series Speedlite.

- The actual display will show only the applicable items.



## Viewfinder Information

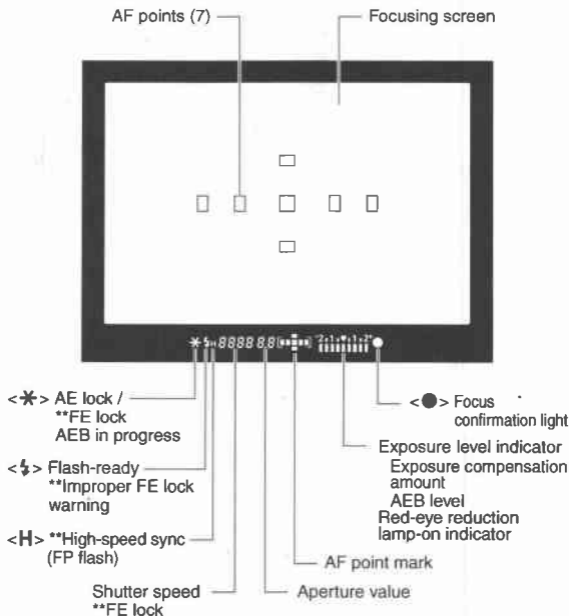

# Nomenclature

## Mode Dial

The dial is divided into two zones.

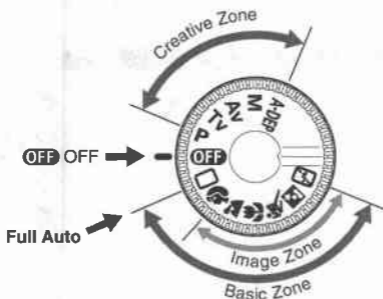

### ① Basic Zone

Fully automatic mode where the camera takes care of everything.

 : **Full Auto** (p.18)

Basically, all you do is point and shoot.

#### **Image Zone** (p.20)

Fully automatic modes for a particular subject.

 : Portrait

 : Landscape

 : Close-up

 : Sports

 : Night Portrait

 : Flash off

### ② Creative Zone

Semi-automatic and manual modes enable you to take control of the camera to obtain the desired result.

**P** : Program AE (p.32)

**Tv** : Shutter-priority AE (p.34)

**Av** : Aperture-priority AE (p.35)

**M** : Manual exposure (p.36)

**A-DEP** : Automatic Depth-of-field AE (p.37)

### ③ **OFF** : OFF

# 1 Before You Start

## Installing the Batteries

\* Batteries are not included in camera body only (not kit) sold in North America. Obtain batteries separately.

The camera uses two CR2 lithium batteries.



### 1 Open the battery compartment cover.

- Slide the release lever in the direction shown by the arrow in the diagram, and open the cover.



### 2 Install the batteries.

- Make sure the battery contacts (+ and -) are properly oriented as shown.
- Do not mix old and new batteries.



### 3 Close the battery compartment cover.

- Press the cover until it snaps shut.
- The date and time must be set. See page 26. (DATE Model only)



For places where CR2 batteries may not be easily available, take spare batteries with you. Also carry spare batteries for extended shooting sessions.

# Checking the Battery Level

Check the battery level after replacing the batteries and before using the camera.



## Turn the Mode Dial to a shooting mode.

- The camera will then turn on and the LCD panel will display one of the following battery level mark:

 : Battery level OK.

 : The battery level is low. Keep spare batteries handy.

 : The batteries will soon be completely exhausted.

 : Replace the batteries.

## Battery Life

(With 24-ex. rolls)

Temperature	0% Flash Use	50% Flash Use	100% Flash Use
At 20°C	67 rolls	30 rolls	22 rolls
At -10°C	44 rolls	20 rolls	15 rolls

- The battery life shown above is based on Canon's testing conditions with new batteries.



- If nothing is displayed on the LCD panel, the batteries may have been installed incorrectly. Take out the batteries and install correctly.
- If you often press the shutter button halfway for a prolonged period or just autofocus without taking a picture, the battery life will be affected.
- When not using the camera, set the Mode Dial to <OFF>.

# Mounting and Detaching a Lens

## Mounting a Lens



Red dots

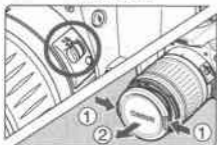

### 1 Remove the caps.

- Remove the rear lens cap and the camera body cap.

### 2 Mount the lens.

- Align the red dots on the lens and camera and turn the lens as shown by the arrow until it snaps in place.

### 3 On the lens, set the focus mode switch to <AF>.

- If the focus mode switch is set to <MF>, autofocus will not operate.

### 4 Remove the front lens cap.

## Detaching the Lens

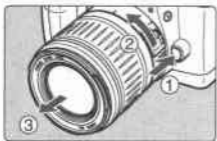

While pressing the lens release button, turn the lens as shown by the arrow.

- Turn the lens until it stops, then detach it.



- Keep the removed caps where you will not lose them.
- <AF> stands for "Auto Focus," and <MF> stands for "Manual Focus."
- An EF-S lens cannot be attached to the camera.

## How the Shutter Button Works

The shutter button has two stages. You can press it down halfway or fully. The two levels of shutter button operation are as follows:



### When it is pressed halfway:

- Pressing the shutter button down halfway activates autofocusing (AF), and also activates the automatic exposure (AE) mechanism and sets the shutter speed and aperture value.
- The exposure (the combination of shutter speed and aperture value) appears on the LCD panel and in the viewfinder (☉4).



### When it is pressed fully:

- The shutter is released to take the picture and the film advances by one frame.

❗ If an Extender (optional) is used and the maximum aperture (the lowest f/number) of the lens becomes smaller than f/5.6, autofocusing will not operate.



Camera movement during the moment of exposure is called camera shake. Camera shake can cause blurred pictures. To prevent blurred pictures due to camera shake:

- Hold the camera steady.
  - Firmly grasp the camera grip with your right hand, and press your both elbows lightly against your body.
  - Hold the lens at the bottom with your left hand.
  - Press the camera against your face and look through the viewfinder.
  - To maintain a stable stance, place one foot in front of the other instead of lining up both feet.
- Use your finger tip to touch the shutter button, grasp the camera with your entire right hand, then press the shutter button gently.

# Ⓞ Loading and Unloading Film

## Loading Film

After you load the film, the camera first winds the entire roll onto the camera's take-up spool. With DX-coded film, the camera automatically sets the film's ISO speed. Then each time a picture is taken, one frame of film is rewound back into the film cartridge. The frame counter shows always number of shots remaining.

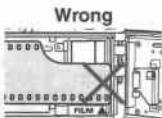
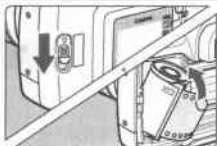

- 1 Turn the Mode Dial to any setting except <OFF>.**
- 2 Open the back cover.**
  - Slide down the back cover release lever and open the back.
- 3 Insert the film cartridge at a slight angle.**
- 4 Align the film leader edge with the <▲> mark.**
  - Hold down the film cartridge while pulling out the film leader. If you pull out the film leader too much, rewind it back into the film cartridge.
- 5 Close the back cover.**
  - Close the back cover until it snaps shut.
    - ▶ Film prewind will start and there will be a shutter-release sound about 10 sec. later. The <Ⓞ> icon and frame count will also be displayed on the LCD panel.
    - ▶ During the film prewind, the ISO speed will be displayed on the LCD panel.

## Ⓢ Loading and Unloading Film

- ! The shutter curtains have been manufactured with very high precision. Never touch them with your fingers. When loading film, do not touch or damage the curtains with your fingers or film.
- In hot and humid environments, do not remove the film packaging until you are ready to load the film.
- Infrared film cannot be used with this camera.



If the film is not loaded properly, the <Ⓢ> icon will blink on the LCD panel and the shutter will not work. Reload the film cartridge properly.

### Unloading Film

After the film's last frame is exposed, the camera rewinds the film automatically.



After the film is rewound, there will be a shutter-release sound. Check that the <Ⓢ> icon is blinking on the LCD panel, then open the back cover and take out the film cartridge.

### Ⓢ Midroll Rewind

To rewind the film in midroll, follow the procedure below.

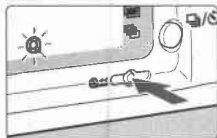

**Press the <Ⓢ> button.**

- ▶ Film rewind will begin.
- Make sure the <Ⓢ> icon is blinking, then take out film cartridge.

- ! If you take out the film cartridge in midroll without rewinding the film and then load a new roll of film and press the shutter button completely, the new film will only rewind into the cartridge. Before loading a new roll of film in this case, close the camera back and press the shutter button.





## □ Full Auto Mode

All you do is point the camera and press the shutter button. Everything is automatic so it is easy to photograph any subject. With seven AF points to focus the subject, anyone can just point and shoot.



**1 Turn the Mode Dial to <□>.**



**2 Aim any of the AF points on the subject.**

- The main subject, as determined by the camera, will be focused by one of the AF points.
- To focus a subject not covered by any of the AF points, see "Focus Lock" on page 29.



**3 Focus the subject.**

- Press the shutter button halfway to focus.
  - ▶ When necessary, the built-in flash will pop up automatically.
  - ▶ When focus is achieved, the AF point mark and focus confirmation light <●> in the viewfinder will flash.

Shutter speed  
Aperture value  
AF point mark

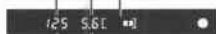

**4 Check the exposure setting.**

- ▶ The shutter speed and aperture value will be set automatically and displayed in the viewfinder and on the LCD panel.



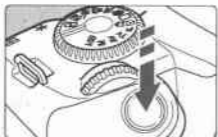





## 5 Take the picture.

- Compose the shot and press the shutter button fully.



- If you want to zoom, do it before focusing. Turning the zooming ring after achieving focus may throw off the focus.
- If the built-in flash's pop-up operation is obstructed, the  icon will blink on the LCD panel. Press the shutter button halfway to resolve the problem.







- When focus is achieved, the autofocus and auto exposure setting will also be locked.
- If the focus confirmation light  blinks, the picture cannot be taken. (p.30)
- Out of the seven AF points, the one covering the closest subject is selected automatically to achieve focus.
- If multiple AF point marks will light, it means that all of them have achieved focus at the respective points.
- In the Basic Zone modes (except    ), the built-in flash will pop up and fire automatically in low-light or backlit conditions. To retract the flash, push it back down.

## AF-Assist beam with the Built-in Flash

Under low-light conditions, the built-in flash fires a brief burst of flashes when you press the shutter button halfway. This is to illuminate the subject to enable easier autofocusing.



- The AF-assist beam does not function in the    modes.
- The built-in flash's AF-assist beam is effective up to about 4 meters/13.1 feet.
- In the Creative Zone modes when the built-in flash is popped up with the  button, the AF-assist beam may be emitted.

# Programmed Image Control Modes

Select a shooting mode to suit the target subject, and the camera will be set to obtain the best results.



## Portrait



This mode blurs the background to make the human subject stand out.

- Holding down the shutter button executes continuous shooting.
- To improve the background blur, use a telephoto lens and fill the frame with the subject or have the subject stand farther away from the background.



## Landscape



This is for wide scenic views, night scenes, etc.

- Using a wide-angle lens will further enhance the depth and breadth of the picture.



## Close-up



Use this mode to take close-up shots of flowers, insects, etc.

- As much as possible, focus the subject at the lens' closest focusing distance.
- To obtain a larger magnification, use the telephoto end of a zoom lens.



A blinking shutter speed indicates that the shutter speed is too slow to prevent a blurred picture due to camera shake. Be careful to hold the camera steady and press the shutter button smoothly, or use a tripod. (The shutter speed indicator still blinks when you use a tripod, but camera shake will not be a problem.)



## Sports



This is for fast-moving subjects when you want to freeze the action.

- The camera will first track the subject with the center AF point. Focus tracking will then continue with any of the seven AF points covering the subject.
- While you hold down the shutter button, focusing will continue for continuous shooting.
- Using a telephoto lens and ISO 400 or higher speed film is recommended.



## Night Portrait



This mode is for taking pictures of people at twilight or at night. The flash illuminates the subject while a slow sync speed obtains a natural-looking exposure of the background.

- If you want to photograph only a night scene (without people), use the <  > mode instead.
- Tell the subject to keep still even after the flash fires.



## Flash off





You can disable the flash when you do not want it to fire.

- The built-in flash or any external Speedlite will not fire.



In the <  > mode, use a tripod to prevent camera shake.

## Using Red-eye Reduction (with the built-in flash)

When flash is used in a low-light environment, the subject's eyes may come out red in the photograph. To reduce this "Red eye" the red-eye reduction lamp shines a light into the subject's eyes before the flash is fired. Red-eye reduction works in all shooting modes except  >  > .





### 1 Move the arrow to the icon on the LCD panel.

- Look at the LCD panel and press the <FUNC.> button to move the arrow. (06)



### 2 Turn the dial to set "1" on the LCD panel.

- Press the shutter button halfway to return to normal camera operation.
- To cancel red-eye reduction, set "0" on the LCD panel.

- 
- When you press the shutter button halfway, the red-eye reduction lamp-on indicator will appear in viewfinder and on the LCD panel.
  - Red-eye reduction will not work unless the subject looks at the red-eye reduction lamp. Tell the subject to look at the lamp.
  - For maximum effectiveness, press the shutter button fully after the red-eye reduction lamp turns off (after 1.5 sec.).
  - You can take a picture even while the red-eye reduction lamp is lit.
  - The effectiveness of red-eye reduction varies depending on the subject.
  - To further increase the effectiveness of red-eye reduction, go to a brighter environment or move closer to the subject.
- 
- Red-eye reduction lamp-on indicator

## Self-timer Operation

You can use self-timer in any Basic mode or Creative mode. We recommend using a tripod when you use the self-timer.

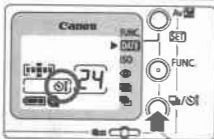

### 1 Press the **< [Self-timer icon] / [i] >** button.

- While looking at the LCD panel, press the **< [Self-timer icon] / [i] >** button to select **< [Self-timer icon] >**.



### 2 Take the picture.

- The picture-taking procedure is the same as with the **< [Full Auto icon] >** Full Auto mode on page 18.
- Look through the viewfinder and press the shutter button fully to start the self-timer.
  - ▶ The picture will be taken about 10 sec. later.
    - First 8 sec.: Self-timer lamp blinks slowly.
    - Final 2 sec.: Self-timer lamp blinks quickly.
  - ▶ During the self-timer operation, the LCD panel counts down the seconds until the picture is taken.

**!** Do not stand in front of the camera when you press the shutter button to start the self-timer. Doing so prevents the camera from focusing on the subject.

- To cancel the self-timer after it starts, press the **< [Self-timer icon] / [i] >** button.
- When using the self-timer to take a picture of only yourself, first lock the focus (p.29) on an object at the same distance where you will be in the picture.

## Wireless Remote Control (DATE Model only) ■

With Remote Controller RC-5 (optional), wireless operation is possible up to 5 m/16.4 ft away from the front of the camera.

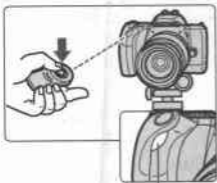

Remote control sensor

- 1 Press the < [Camera Icon] / [Self-Timer Icon] > button.**
  - While looking at the LCD panel, press the < [Camera Icon] / [Self-Timer Icon] > button to select < [Self-Timer Icon] >.
- 2 Take the picture.**
  - Point the controller toward the camera's remote control sensor and press the transmit button.
    - ▶ Taken about 2 sec. later.
  - The indicator will be the same as during the last 2 sec. of the self-timer.

⚠ Certain types of fluorescent lights might cause the remote control operation to work improperly. Place the camera away from any fluorescent lights as far as possible.

🔋 If you set < [Self-Timer Icon] > and do nothing for four minutes, the remote control mode will be canceled automatically to save battery power.

## Using the Eyepiece Cover

During self-timer or remote control operation when your eye does not cover the viewfinder eyepiece, stray light may enter the eyepiece and affect the exposure when the picture is taken. To prevent this, use the eyepiece cover to cover the eyepiece. (p.7)

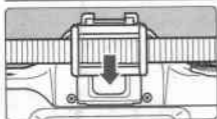

- 1 Remove the eyecup from the eyepiece.**
- 2 Attach the eyepiece cover.**
  - Slide the eyepiece cover down into the eyepiece groove to attach it.

⚠ When you reattach the eyecup, press it with your fingers so that it is attached tightly to the camera.



## DATE Imprinting the Date or Time (DATE Model only) ■



Date position

The camera has a date feature with an automatic calendar to 2099. It can imprint the date or time on the photograph as shown in the left photo.

The date or time can be imprinted in any shooting mode.

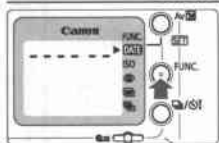

### 1 Move the <▶> arrow to <DATE>.

- Look at the LCD panel and press the <FUNC.> button. (⊙6)
- If the date and time has not been set, "-----" will blink on the LCD panel. See page 26 to set the date and time.

### 2 Select the date format.

- Turn the <🕒> dial.
  - ▶ The date format will change in the following loop:



## DATE Imprinting the Date or Time (DATE Model only) ■

### Setting the Date and Time

**1** Move the <▶> arrow to <DATE>.



**2** Select the digit to be set.

- Press the <SET> button.
- The digit selection will change in the following sequence: year, month, day, hour, minute, ":".



**3** Set the correct number.

- Turn the <☀> dial.
- Repeat steps 2 and 3 until all the date and time digits are set correctly.

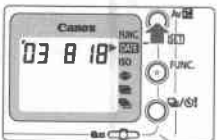

**4** Finalize the date and time setting.





- Keep pressing the <SET> button until no digits are blinking.
- If you press the <SET> button while ":" is blinking, 0 sec. will be set.

**!** If a picture is taken while the date and time are blinking, the date and time will not be imprinted on that picture.

**!** The date and time setting can be retained for about 10 min. after the camera's batteries are removed.

# User-Controlled Shooting

# 3

 Selecting an AF point.....	28
Focus Lock.....	29
When Autofocus Fails (Manual Focusing).....	30
 Selecting the Film Advance Mode.....	31
Metering Modes.....	31
<b>P</b> Program AE.....	32
<b>Tv</b> Shutter-Priority AE.....	34
<b>Av</b> Aperture-Priority AE.....	35
<b>M</b> Manual Exposure.....	36
<b>A-DEP</b> Automatic Depth-of-Field AE.....	37
<b>Av</b>  Exposure Compensation.....	38
 Auto Exposure Bracketing (AEB).....	39
<b>*</b> AE Lock.....	40
Bulb Exposures.....	41
 Multiple Exposures.....	41
ISO Setting the ISO Film Speed.....	42
Using the Built-in Flash.....	43



With Creative Zone modes, you can set the desired shutter speed or aperture value to obtain the exposure you want. You take control of the camera.

- In Creative Zone modes, you can select the desired AF point and set the film advance mode, exposure compensation amount, AEB, AE lock, bulb exposures, multiple exposures, and ISO speed.

## Selecting an AF point

The AF point is used for focusing. The AF point can be selected automatically by the camera or manually by you. In the Basic Zone modes and **<A-DEP>** mode, the AF point selection is automatic only. In the **<P>** **<Tv>** **<Av>** **<M>** modes, the AF point can be selected either automatically or manually.

### • Automatic AF point Selection

The camera selects the AF point automatically according to situation.

### • Manual AF point Selection

You can select any of the seven AF points manually. This is best when you want to be sure to focus on a particular subject, or to compose a particular shot quickly.

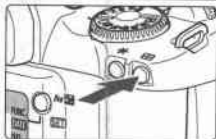

### 1 Press the button. (Ⓞ6)

- ▶ The current AF point will be indicated on the LCD panel and in the viewfinder.



### 2 Select the desired AF point.

- While looking at the LCD panel or viewfinder, turn the  dial.
- After selecting the AF point, press the shutter button halfway. The camera will then be ready to take pictures.

Automatic AF  
Point Selection

Manual AF  
Point Selection

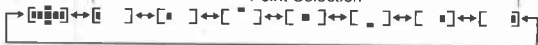

## Focus Lock

After achieving focus, you can lock the focus on a subject and recompose the shot. This is called "focus lock."

### 1 Set the camera to a Creative Zone mode.

- Set a Creative Zone mode except <A-DEP>.

### 2 Select the desired AF point.

### 3 Focus the subject.

- Aim the AF point on the subject, then press the shutter button halfway.



### 4 Keep pressing the shutter button halfway and recompose the picture as desired.

### 5 Take the picture.



- If focus has not been achieved, the focus confirmation light <●> in the viewfinder will blink. In this case, you cannot take a picture even when you press the shutter button fully. Recompose the shot and focus again or see "When Autofocus Fails" (p.30).
- If you use an external, EOS-dedicated Speedlite and focus cannot be achieved with the AF-assist light, select the center AF point.
- Focus lock also works in the Basic Zone modes (except <M>). Just start from step 3 above.

## When Autofocus Fails (Manual Focusing) ■

Autofocus can fail to achieve focus (the focus confirmation light <●> blinks) with certain subjects such as the following:

### Difficult Subjects for Autofocusing

- Low-contrast subjects.  
Example: Blue sky, flat surface with a solid color.
- Subjects in very low light.
- Extremely backlit or reflective subjects.  
Example: Automobile with a strong reflection.
- Overlapping near and far objects.  
Example: Animal behind bars in a cage.

In such cases, do one of the following:

- (1) Focus lock an object at the same distance as the subject and recompose.
- (2) Set the lens focus mode switch to <MF> and focus manually.

### MF Manual Focusing

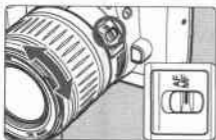

Focus ring

- 1 Set the lens focus mode switch to <MF>.**
- 2 Focus the subject.**
  - Focus by turning the lens focusing ring until the subject is in focus in the viewfinder.



If you hold down the shutter button halfway while focusing manually, the active AF point mark and the focus confirmation light <●> will light when focus is achieved.

## Selecting the Film Advance Mode

Two film advance modes are provided: single-frame and continuous shooting (Max. 1.5 frames per sec.).



Press the **<M/>** button.

- Look at the LCD panel and press the **<M/>** button.

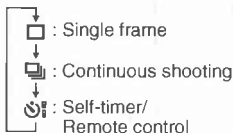

## Metering Modes

The camera has three metering modes: Evaluative, partial, and center-weighted average metering.



### Evaluative metering

This is the camera's standard metering mode suited for most shooting including backlit conditions. Based on the subject's position in the viewfinder, brightness, background, front or back lighting conditions, etc., the camera always calculates the proper exposure for the subject.

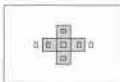

### Partial metering

This mode is set automatically when AE lock is used in a Creative Zone mode. It is effective for backlit subjects when there is a strong light behind the subject. The viewfinder center covering about 9.5% of the viewfinder area is used for metering. The partial metering area is shown on the left.



### Center-weighted average metering

This is set automatically in the **<M>** mode. The metering is weighted at the center and then averaged for the entire scene.

# P Program AE



Like the <□> (Full Auto) mode, this is a general-purpose mode to make picture-taking easy. It sets the shutter speed and aperture value automatically to suit the subject's brightness.

\* <P> stands for Program.

\* "AE" stands for auto exposure.



AF point

## 1 Turn the Mode Dial to <P>.



## 2 Focus the subject.

- Move the AF point over the subject and press the shutter button halfway.

Shutter speed

Aperture value

AF point mark

## 3 Check the display.

- ▶ The shutter speed and aperture value are set automatically and displayed in the viewfinder and on the LCD panel.
- If the shutter speed and aperture value do not blink, a correct exposure will be obtained.







## 4 Take the picture.

- Compose the shot and press the shutter button fully.



30" 4.0

2000 2.2

- If "30'" and the maximum aperture value blink, it indicates underexposure. Use flash.
- If "2000" and the minimum aperture value blink, it indicates overexposure. Use an ND filter to reduce the light entering the lens.



### The Difference Between <P> and <□>

- The shutter speed and aperture value are set in the same way in both modes.
- The following features can be used in the <P> mode, but not in the <□> mode.
  - Manual AF point selection
  - Film advance mode selection
  - Program shift
  - Exposure compensation
  - AEB
  - AE lock with the <★> button
  - Multiple exposures
  - Built-in flash manual firing and flash OFF
  - FE lock, high-speed sync (with EX-series Speedlites)

### About Program Shift

- In the Program AE mode, you can freely change the shutter speed and aperture value combination (program) set by the camera while retaining the same exposure. This is called program shift.
- To shift the program, press the shutter button halfway and turn the <☀> dial until the desired shutter speed or aperture value is displayed.
- Program shift is canceled automatically after the picture is taken.
- Program shift cannot be set when the built-in flash is used.

# Tv Shutter-Priority AE

In this mode, you set the shutter speed and the camera sets the aperture value automatically to suit the subject brightness. A fast shutter speed can freeze the motion of a fast-moving subject and a slow shutter speed can blur the subject to give the impression of motion.

\* <Tv> stands for Time value which is the shutter speed.

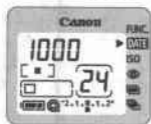

**1 Turn the Mode Dial to <Tv>.**

**2 Select the desired shutter speed.**

- Turn the <  > dial.
- The shutter speed can be set in half-stop increments.

**3 Focus the subject.**

- ▶ The aperture value is set automatically.

**4 Check the viewfinder display and take the picture.**

- If the aperture value display is not blinking, a correct exposure will be obtained.

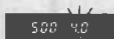

- If the maximum aperture value blinks, it indicates underexposure. Turn the <  > dial to set a slower shutter speed until the blinking stops.

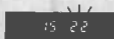

- If the minimum aperture value blinks, it indicates overexposure. Turn the <  > dial to set a faster shutter speed until the blinking stops.



## Shutter Speed Display

The shutter speeds from "2000" to "2" indicate the denominator of the fractional shutter speed. For example, "125" indicates 1/125 sec. Also, "0.7" indicates 0.7 sec, and "15" indicates 15 sec.

# Av Aperture-Priority AE

In this mode, you set the desired aperture value and the camera sets the shutter speed automatically to suit the subject brightness. The larger or brighter the aperture value (lower f/number) the more blurred the background will become. This effect is ideal for portraits. The smaller or darker the aperture value (higher f/number), the clearer the focus will be for both near and far objects (wider depth of field).

\* <Av> stands for aperture value.

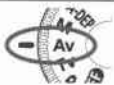

**1** Turn the Mode Dial to <Av>.

**2** Select the desired aperture value.

- Turn the <☀> dial.
- The aperture value can be set in half-stop increments.

**3** Focus the subject.

- ▶ The shutter speed is set automatically.

**4** Check the viewfinder display and take the picture.

- If the shutter speed display does not blink, a correct exposure will be obtained.

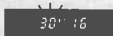

- If the slowest shutter speed blinks, it indicates underexposure. In such a case, turn the <☀> dial to set a larger aperture value (smaller f/number) until the shutter speed display stops blinking.



- If the fastest shutter speed blinks, it indicates overexposure. In such a case, turn the <☀> dial to set a smaller aperture value (larger f/number) until the shutter speed display stops blinking.



## Aperture Value Display

The larger the f/number, the smaller the diaphragm will be. The aperture value display will differ depending on the lens. When no lens is attached to the camera, "00" will be display for the aperture value.

# M Manual Exposure

In this mode, you set both the shutter speed and aperture value as desired. To determine the exposure, refer to the exposure level indicator in the viewfinder or use a handheld exposure meter. This method is called manual exposure. In the <M> mode, the center-weighted average metering will be set automatically.

\* <M> stands for Manual.



**1 Turn the Mode Dial to <M>.**

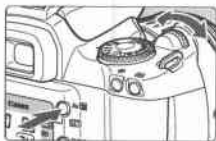

**2 Set the shutter speed and aperture value.**

- To set the shutter speed, turn the <S> dial.
- To set the aperture value, hold down the <Av [ ]> button and turn the <S> dial.



**3 Focus the subject.**

- ▶ The exposure setting will be displayed.
- The exposure level mark <|> indicates how close the exposure level is to the correct exposure.

**4 Determine the exposure.**

- Look at the exposure level indicator and set the shutter speed and aperture value as desired.

**5 Take the picture.**

Exposure level mark



If the exposure level mark <|> blinks at the <2+> or <-2> level, it indicates that the difference between the standard exposure exceeds +/-2 stops.

## A-DEP Automatic Depth-of-Field AE

This mode is for obtaining a wide depth of field automatically between a near subject and far subject. It is effective for group photos and landscapes.

The camera uses the 7 AF points to detect the nearest and farthest subjects to be in focus.

\* <A-DEP> stands for Auto-depth of field.



**1 Turn the Mode Dial to <A-DEP>.**



**2 Focus the subject.**

- Move the AF point over the subject and press the shutter button halfway.
- Focus is achieved at all the AF point marks that light.

**3 Take the picture.**



The <A-DEP> mode cannot be used if the lens' focus mode switch is set to <MF>.



- If the aperture value blinks, it indicates that the exposure level is correct but the desired depth of field cannot be achieved. Either use a wide-angle lens or move further away from the subjects.
- In this shooting mode, you cannot freely change the shutter speed and aperture value. If the camera sets a slow shutter speed, hold the camera steady or use a tripod.
- If flash is used, the result will be the same as using flash in the <P> mode.

## Av Exposure Compensation



Exposure compensation is used to alter the camera's standard exposure setting. You can make the picture look lighter (increased exposure) or darker (decreased exposure). The exposure compensation amount can be set up to  $\pm 2$  stops in half-stop increments.

**1 Turn the Mode Dial to a Creative Zone mode except <M>.**

**2 Check the exposure setting.**

- Press the shutter button halfway and check the display.

**3 Set the exposure compensation amount.**

- Hold down the <Av  > button and turn the < > dial.
- To cancel the exposure compensation, set the exposure compensation amount to <i>.

**4 Take the picture.**

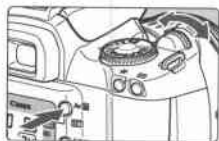
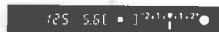

Standard exposure index



Decreased exposure ← → Increased exposure

Exposure level mark

- The exposure compensation amount set is retained even after the Mode Dial is set to <OFF>.
- The exposure compensation amount is canceled automatically when you turn the Mode Dial to a Basic Zone mode.
- Assuming that a shutter speed of 1/125 sec. and an aperture value of f/5.6 will give a correct exposure, setting the exposure compensation amount to plus or minus 1 stop will change the shutter speed or aperture value as follows:

	-1 stop	←	0	→	+1 stop
Shutter speed	250	←	125	→	60
Aperture value	8.0	←	5.6	→	4.0

# Auto Exposure Bracketing (AEB) ■■■■

With AEB, the camera automatically changes the exposure within the set range (up to  $\pm 2$  stops in  $1/2$ -stop increments) for three successive frames.

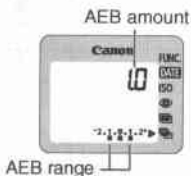

## 1 Move the arrow to the icon.







- Look at the LCD panel and press the <FUNC.> button. (06)

## 2 Set the desired AEB amount.

- Turn the  dial.
- Press the shutter button halfway to return to normal camera operation.

## 3 Take the picture.

- ▶ The three bracketed shots will be exposed in the following sequence: standard exposure, decreased exposure, and increased exposure.
- ▶ As shown on the left, the respective bracketing amount will be displayed as each bracketed shot is taken.
- The picture will be taken in the current film advance mode.
- After the three AEB shots are taken, the AEB will not be canceled automatically. To cancel AEB, set the AEB amount back to "00".

-  During AEB shooting, the  arrow will appear next to the  icon and the AEB level  will be displayed. In the viewfinder, the  icon will blink.
- In the  film advance mode, the camera stops shooting automatically after taking the three AEB shots. In the  (single frame) mode, press the shutter button completely three times to take the three AEB shots.
- If you use the self-timer or remote control, the three AEB shots will be taken continuously automatically.
- AEB can be combined with exposure compensation.
- AEB cannot be used with flash or bulb exposures.

## \* AE Lock

AE lock enables you to lock the exposure at a different place from the point of focus. After locking the exposure, you can recompose the shot while maintaining the desired exposure level. This feature is useful for backlit and spotlighted subjects. For AE lock, partial metering is used automatically.

### 1 Focus the subject.

- ▶ The exposure setting will be displayed.

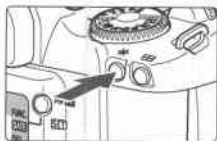

### 2 Press the <\*> button. (04)

- Aim the center of the viewfinder over the subject where the exposure is to be locked, then press the <\*> button.
  - ▶ The <\*> icon will light in the viewfinder to indicate that the exposure setting has been locked (AE lock).
- Each time you press the <\*> button, it locks the current exposure setting.



AE lock indicator

### 3 Compose the shot and take the picture.



- If you want to maintain the AE lock while taking more pictures, hold down the <\*> button and press the shutter button to take another picture.





## Bulb Exposures



When bulb is set, the shutter is open during the time you keep pressing the shutter button fully. Bulb exposures are useful when long exposures are required for night scenes, fireworks, astronomical photography, etc.

- 1 Turn the Mode Dial to <M>.**
- 2 Set the shutter speed to "bulb".**
  - Look at the LCD panel and turn the  dial to select "bulb".
  - "bulb" follows "30".
- 3 Select the desired aperture value.**
  - Hold down the <Av> button and turn the  dial.
- 4 Start the bulb exposure.**
  - ▶ During the bulb exposure, "bulb" blinks on the LCD panel.
  - The bulb exposure continues as long as you hold down the shutter button.

-  • Remote Controller RC-5 (optional) can also be used for bulb exposures (p.24). When you press the transmit button, the exposure will start 2 sec. later. To stop the exposure, press the button again. (DATE Model only)
- With a new set of batteries, the maximum bulb exposure time (at 20°C) will be about 4 hours.

## Multiple Exposures

Since the film is not advanced after each shot, you can expose multiple shots on the same frame. You can expose up to nine shots on a single frame.

- 1 Move the <▶> arrow to the  icon.**
  - Look at the LCD panel and press the <FUNC.> button. (⊙6)
  - ▶ "1" will be displayed.
- 2 Set the desired number of multiple exposures.**
  - Turn the  dial.
  - Press the shutter button halfway to return to normal camera operation.

## Multiple Exposures

### 3 Take the picture.

- ▶ After you take all the multiple exposures, the film advances to the next frame automatically and the multiple-exposure setting is canceled.



If you shoot multiple exposures on the first few or last few frames of a roll, the multiple exposures might not be precisely aligned due to the film curling.



- During multiple-exposure shooting, the <▶> arrow next to the <📷> icon on the LCD panel will blink.
- To cancel multiple exposures before shooting, set the number of multiple exposures to "1".
- To cancel multiple exposures after shooting, follow steps 1 and 2 to set the number of multiple exposures to blank.

## ISO Setting the ISO Film Speed

If the film is not DX-coded or if you want to set a different film speed, load the film in the camera and set the film speed manually as follows. The settable film speed range is ISO 6 to 6400.



### 1 Move the <▶> arrow to the <ISO> icon.

- Look at the LCD panel and press the <FUNC.> button to move the arrow. (📷)
- ▶ The current film speed is displayed.

### 2 Set the desired film speed.

- Turn the <📷> dial to set the film speed.



The manually-set film speed will be canceled if the film is taken out and DX-coded film is loaded.

# Using the Built-in Flash

## In a Basic Zone Mode

In low-light or backlit conditions, the built-in flash will pop up and fire automatically (except in <img alt="Landscape icon" data-bbox="385 150 415 170"/> <img alt="Night icon" data-bbox="425 150 455 170"/> <img alt="Flash icon" data-bbox="465 150 495 170"/> modes).

## In a Creative Zone Mode

Press the <img alt="Flash icon" data-bbox="215 225 245 245"/> button to pop up the built-in flash.

- P** : Use this mode for automatic flash photography. The flash sync speed (1/90 sec.) and aperture value will be set automatically as with the <img alt="Full Auto icon" data-bbox="305 305 335 325"/> (Full Auto) mode.
- Tv** : Use this mode if you want to set the flash sync speed manually (within 30 sec. - 1/90 sec.). The camera will set the flash aperture value automatically to obtain a correct flash exposure.
- Av** : Use this mode if you want to set the flash aperture value. The camera will set the flash sync speed (within 30 sec. - 1/90 sec.) automatically to obtain the best exposure for the aperture you set. For portraits with a night scene or dark background, a slow sync speed will be set to obtain a proper exposure for both the subject and background. The flash illuminates the subject, while the background is properly exposed with a slow shutter speed.
- Because automatic slow-sync shooting uses a slow shutter speed, always use a tripod.
- M** : You can manually set both the flash sync speed (within Bulb - 1/90 sec.) and aperture value. The subject is properly exposed with the flash and the background is exposed with the flash sync speed and aperture value you have set.
- A-DEP** : The result will be the same as using the <img alt="P mode icon" data-bbox="695 760 725 780"/> mode.

**Flash Distance Range** (With EF28-90mm f/4-5.6)

[m/ft]

ISO	28mm		90mm	
	Negative Film	Slide Film	Negative Film	Slide Film
100	1-4.2 / 3.3 - 13.9	1-3.0 / 3.3 - 9.8	1-3.0 / 3.3 - 9.8	1-2.1 / 3.3 - 7.0
400	1-8.5 / 3.3 - 27.8	12-6.0 / 3.9 - 19.7	1-6.0 / 3.3 - 19.7	1-4.2 / 3.3 - 13.9

## Using the Built-in Flash

Flash Distance Range (With EF28-80mm f/3.5-5.6)

[m/ft]

ISO	28mm		80mm	
	Negative Film	Slide Film	Negative Film	Slide Film
100	1 - 4.8 / 3.3 - 15.9	1 - 3.4 / 3.3 - 11.2	1 - 3.0 / 3.3 - 9.8	1 - 2.1 / 3.3 - 7.0
400	1 - 9.7 / 3.3 - 31.8	1.2 - 6.8 / 3.9 - 22.5	1 - 6.0 / 3.3 - 19.7	1 - 4.2 / 3.3 - 13.9



- When using the built-in flash, stay at least 1 meter/3.3 feet away from the subject. Otherwise, part of the photo will look dark.
- When using the built-in flash, detach any hood attached to the lens. A lens hood will partially obstruct the flash coverage.
- When a super telephoto lens or a fast, large-aperture lens is attached, the built-in flash coverage might be obstructed.
- The built-in flash's flash coverage is 28mm lens angle.
- If you use a flash unit (with multiple contacts) dedicated to another camera brand or a high-voltage flash, the camera may not work properly or malfunction may result.



- To retract the built-in flash, push it down.
- If more light is required, use an external, EOS-dedicated Speedlite (optional).

## Reference

### Feature Availability Table

● : Set automatically. ○ : User-selectable/settable.

Mode Dial Mode												
AF	One Shot		●	●	●		●				●	
	AI Servo						●					
	AI Focus	●					●	●	●	●		
	AF Point Selection	Auto	●	●	●	●	●	○	○	○	○	●
	Manual						○	○	○	○		
Film Advance	Single frame	●		●	●		●	○	○	○	○	○
	Continuous		●					○	○	○	○	○
	Self-timer/ Remote control	○	○	○	○	○	○	○	○	○	○	○

## AF Mode and Film Advance Mode

AF Mode	Single frame	Continuous
One Shot AF	The picture cannot be taken until focus is achieved. When focus is achieved, it also locks at the same time. The evaluative metering's exposure setting is also locked. (The exposure setting is retained until the picture is taken.)	The same conditions explained on the left apply during continuous shooting. (Max. 1.5 frames per sec.)
AI Servo AF	The subject is focus-tracked for continuous autofocus. The exposure is set when the picture is taken.	The same conditions explained on the left apply during continuous shooting. Autofocusing continues during continuous shooting. (Max. 1.3 frames per sec.)
AI Focus AF	Automatically switches between One Shot AF and AI Servo AF according to the subject status.	

## Troubleshooting Guide

If there is a problem, first refer to this Troubleshooting Guide.

- **Nothing is displayed on the LCD panel.**

**The batteries are exhausted. / The batteries have been installed incorrectly.**

- ▶ Replace the batteries with new ones. / Install the batteries correctly. (p.11)

- **The picture looks blurred.**

**The lens focus mode switch is set to <MF>.**

- ▶ Set the lens focus mode switch to <AF>. (p.13)

**There was camera shake when the picture was taken.**

- ▶ Hold the camera steady or use a faster shutter speed. (p.14)

- **The shutter does not work.**

**On the LCD panel, the frame count is not displayed and the <@> icon blinks.**

- ▶ Take out the film and load it correctly. (p.15)

**The focus confirmation light <●> in the viewfinder blinks and focus cannot be achieved.**

- ▶ Select another AF point. (p.28)

If focus still cannot be achieved, focus manually. (p.30)

- **The <□> icon blinks on the LCD panel.**

**The battery level is very low.**

- ▶ Replace the batteries with new ones. (p.11)

**A misoperation has occurred.**

- ▶ Press the shutter button halfway. (p.14) / Remove the batteries and reload it. (p.11) If the blinking <□> icon does not turn off, consult your nearest Canon dealer.

# Major Specifications

## • Type

Type .....	35 mm AF/AE SLR camera with built-in flash
Recording media .....	35 mm film
Image size .....	24 x 36 mm
Compatible lenses .....	Canon EF lenses
Lens mount .....	Canon EF mount

## • Viewfinder

Type .....	Eye-level pentamirror
Coverage .....	Approx. 90% vertically and horizontally
Magnification .....	0.7x (-1 diopter with 50mm lens at infinity)
Eyepoint .....	18.5 mm
Focusing screen .....	Fixed, all-matte screen
Mirror .....	Quick-return half mirror (Transmission; reflection rate of 40:60, No mirror cut-off with EF300mm f/2.8L plus Extender 2x or shorter lens)
Viewfinder information .....	AF (AF point/mark, focus confirmation light); Exposure (shutter speed, aperture value, exposure level, AE lock); Flash (flash ready, hi-speed sync, FE lock, red-eye reduction)

## • Autofocus

Type .....	TTL-CT-SIR with a CMOS (Complementary Metal Oxide Semiconductor) sensor
AF points .....	7 AF points
AF working range .....	EV 1 - 18 (ISO 100)
Focusing modes .....	One Shot AF, AI Servo AF, AI Focus AF, manual focusing (MF)
AF point selection .....	Automatic/manual
Selected AF point display .....	AF point mark in the viewfinder and on LCD panel
AF-assist beam .....	Intermittent firing of the built-in flash Working distance: Approx. 4 m/13.1 ft at center, Approx. 3.5 m/11.5 ft at outer edge

## • Exposure control

Exposure metering modes .....	TTL full aperture metering with 35-zone SPC <ul style="list-style-type: none"><li>• Evaluative metering (linkable to any AF point)</li><li>• Partial metering (approx. 9.5% of viewfinder at center)</li><li>• Center-weighted average metering (automatically set in manual exposure mode)</li></ul>
Metering range .....	EV 1 - 20 (normal temperature, 50mm f/1.4, ISO 100)
Exposure control .....	Program AE (Full Auto, Portrait, Landscape, Close-up, Sports, Night Portrait, Flash off, Program), shutter-priority AE, aperture-priority AE, depth-of-field AE, manual exposure, E-TTL/A-TTL/TTL autofocus
Film speeds .....	ISO 6 - 6400 (Set automatically for DX-coded film within ISO 25 - 5000)
Exposure compensation .....	Manual exposure compensation: +/- 2 stops in 1/2-stop increments (can be used with AEB) Auto Exposure Bracketing (AEB): +/- 2 stops in 1/2-stop increments
AE lock .....	Auto AE lock: Operates in One Shot AF mode with evaluative metering when focus is achieved Manual AE lock: By AE lock button in partial metering mode
Multiple exposures .....	Max. 9 exposures

## • Shutter

Type .....	Electronically controlled focal-plane shutter
Shutter speeds .....	1/2000 - 30 sec. in 1/2-stop increments, bulb, X sync at 1/90 sec.
Shutter release .....	Soft touch electromagnetic release
Self-timer .....	Shoot after 10 sec. delay
Remote control .....	Remote Controller RC-1/RC-5 (DATE Model only)

## • Flash

Built-in flash .....	AF point-linked, 3-zone autofocus
	Guide No. 12 (ISO 100, in meters), 39 (ISO 100, in feet)
	Recycling time: Approx. 2 sec.
	Flash coverage: 28 mm lens angle covered
	Red-eye reduction: Lamp
External EOS-dedicated flash .....	E-TTL / A-TTL / TTL autofocus

## • Film transport

Film loading .....	Automatic prewind
Film advance modes .....	Single-frame/continuous shooting
Continuous shooting speeds .....	One Shot AF: Max. 1.5 fps
	AI Servo AF: Max. 1.3 fps
Film rewind .....	Automatic. Mid-roll rewind

## • Date imprinting (DATE Model only)

Automatic dating .....	Automatic calendar to 2099
------------------------	----------------------------

- **Power source** ..... Two CR2 lithium batteries
- **Dimensions (W x H x D)** ..... 130 x 88 x 64 mm/5.1 x 3.5 x 2.5 in
- **Weight** ..... 340 g/12.0 oz (body only)

- All the specifications above are based on Canon's testing and measuring standards.
- Specifications and physical appearance are subject to change without notice.

This device complies with Part 15 of the FCC Rules. Operation is subject to the following two conditions: (1) This device may not cause harmful interference, and (2) this device must accept any interference received, including interference that may cause undesired operation.

Do not make any changes or modifications to the equipment unless otherwise specified in the instructions. If such changes or modifications should be made, you could be required to stop operation of the equipment.

This equipment has been tested and found to comply with the limits for a class B digital device, pursuant to part 15 of the FCC Rules. These limits are designed to provide reasonable protection against harmful interference in a residential installation. This equipment generates, uses and can radiate radio frequency energy and, if not installed and used in accordance with the instructions, may cause harmful interference to radio communications.

However, there is no guarantee that interference will not occur in a particular installation. If this equipment does cause harmful interference to radio or television reception, which can be determined by turning the equipment off and on, the user is encouraged to try to correct the interference by one or more of the following measures:

- Reorient or relocate the receiving antenna.
- Increase the separation between the equipment and receiver.
- Consult the dealer or an experienced radio/TV technician for help.

This digital apparatus does not exceed the Class B limits for radio noise emissions from digital apparatus as set out in the interference-causing equipment standard entitled "Digital Apparatus", ICES-003 of the Industry Canada.



The CE Mark is a Directive conformity mark of the European Community (EC)

# Canon

**CANON INC.** 30-2, Shimomaruko 3-chome, Ohta-ku, Tokyo 146-8501, Japan

**U.S.A.** ————— **CANON U.S.A. INC.**

For all inquiries concerning this camera, call toll free in the U.S.  
1-800-OK-CANON or write to: Customer Relations, Canon U.S.A., Inc.  
One Canon Plaza, Lake Success, N.Y. 11042-1198

**CANADA** —————

**CANON CANADA INC. HEADQUARTERS**

6390 Dixie Road, Mississauga, Ontario L5T 1P7, Canada

**CANON CANADA INC. MONTREAL BRANCH**

5990, Côte-de-Liesse, Montréal Québec H4T 1V7, Canada

**CANON CANADA INC. CALGARY OFFICE**

2828, 16th Street, N.E. Calgary, Alberta T2E 7K7, Canada

For all inquiries concerning this camera, call toll free in Canada  
1-800-OK-CANON

**EUROPE,  
AFRICA &  
MIDDLE EAST** —————

**CANON EUROPA N.V.**

Bovenkerkerweg 59-61, P.O. Box 2262, 1160 EG Amstelveen,  
The Netherlands

**CANON COMMUNICATION & IMAGE FRANCE S.A.**

102, Avenue du Général de Gaulle 92257 La Garenne-Colombes Cedex, France

**CANON UK LTD.**

Woodhatch Reigate Surrey RH2 8BF, United Kingdom

**CANON DEUTSCHLAND GmbH**

Europark Fichlshain A10, 47807 Krefeld, Germany

**CANON ITALIA S.p.A.**

Via Milano 8, San Donato M.SE, Milano, Italy

**CANON Schweiz AG**

Geschäftsbereich Wiederverkauf, Industriestrasse 12, CH-8305 Diellikon,  
Switzerland

**CANON G. m. b. H.**

Oberlaaerstrasse 233, 4th floor, 1100 Wien, Austria

**CANON España, S. A.**

C/Joaquín Costa, 41, 28002 Madrid, Spain

**SEQUE Soc. Nec. de Equip., Lda.**

Praça da Alegria, 58, 2º, 1269-149 Lisboa, Portugal

**CENTRAL &  
SOUTH AMERICA** —————

**CANON LATIN AMERICA, INC. DEPTO DE VENTAS**

703 Waterford Way Suite 400 Miami, FL 33126 U.S.A.

**CANON LATIN AMERICA, INC. CENTRO DE SERVICIO Y REPARACION**

Apartado 2019, Zona Libre de Colón, República de Panamá

**ASIA** —————

**CANON HONGKONG CO., LTD.**

9/F, The Hong Kong Club Building, 3A Chater Road, Central, Hong Kong

**CANON SINGAPORE PTE. LTD.**

79 Anson Road #09-01/06 Singapore 079906

**OCEANIA** —————

**CANON AUSTRALIA PTY. LTD.**

1 Thomas Holt Drive, North Ryde, N.S.W. 2113, Australia

**CANON NEW ZEALAND LTD.**

Akoranga Business Park, Akoranga Drive, Northcote, Auckland, New Zealand

**JAPAN** —————

**CANON SALES CO., INC.**

16-6, Kohnan 2-chome, Minato-ku, Tokyo 108-8011, Japan

This Instruction booklet is current as of June 2003. For information on using the camera with system accessories introduced after this date, contact your nearest Canon Service Center.